



# ExMax - Revolution

Electrical, explosion proof rotary actuators - size S

On-off / 3-pos , 24..230 VAC/DC, 95° Angle of rotation incl. 5° pretention

5/10 Nm - 15/30 Nm without and 5/10 Nm - 15 Nm with safety operation (spring return)

PTB-tested in acc. with ATEX RL 94/9/EG for zone 1, 2, 21, 22.

ExMax - 5.10
ExMax -15.30
ExMax - 5.10 - F
ExMax - 15 - F
ExMax - ... - S/SF
ExMax - ... - VA
ExMax - ... - CT

Subject to change

## Compact - Easy installation - Universal - Cost effective - Safe

Type	Torque	Supply	Motor running time	Spring return	Control mode	Feedback	Wiring diagram
ExMax- 5.10	5 Nm & 10 Nm	24..230VAC/DC	3/15/30/60/120 sec. at 90°	without	On-off, 3-pos	-	SB 1.0
ExMax-15.30	15 Nm & 30 Nm	24..230VAC/DC	3/15/30/60/120 sec. at 90°	without	On-off, 3-pos	-	SB 1.0
ExMax- 5.10 - F	5 Nm & 10 Nm	24..230VAC/DC	3/15/30/60/120 sec. at 90°	3 or 10 sec. at 90°	On-off, 3-pos	-	SB 2.0
ExMax- 15 - F	15 Nm	24..230VAC/DC	3/15/30/60/120 sec. at 90°	3 or 10 sec. at 90°	On-off, 3-pos	-	SB 2.0
ExMax- ... - S/SF	Type as above but with 2 integral, potential free aux. switches, switching at 5° and 85° Angle of rotation, 2 xEPU, max.24V/3A, 230V/0,25A						SB 3.5
ExMax- ... - VA	Type as above but with stainless steel housing (AISI 316) for aggressive ambient (12x12 shaft, shaft manual override, cable glands and hollow rivet nickel-plated)						
ExMax- ... - CT	Type as above but with Al housing and amercoat painting (12x12 shaft connenction, shaft manual override, cable glands and hollow rivet nickel-plated)						

### Application

Damper



Ball valve



Throttle valve

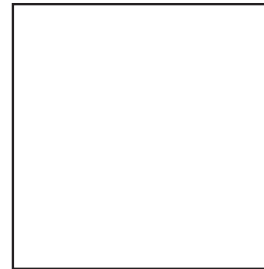

### Description size S Highlights

The new ExMax actuators are a revolution for safety, control and shut-off dampers, VAV systems, ball valves, throttle valves and other motorized applications for HVAC systems, in chemical, pharmaceutical, industrial and Offshore-/Onshore plants, for use in EEx-areas zone 1, 2 (gas) and zone 21, 22 (dust).

Highest protection class (ATEX) and IP 66 protection, small dimensions, only 3,5 kg weight, universal functions and technical data, an integrated heater and an optional stainless steel housing guarantee safe operation even under difficult environmental conditions. High quality brushless motors guarantee long life.

All actuators are programmable and adjustable on site. Special tools or equipment are not required. 5 motor running times and 2 torques as well as 2 spring return times - according to the actuator type - are selectable or adjustable on site. The integrated universal power supply is self adaptable to input voltages in the range of 24 to 230 VAC / DC. The actuators are 100% overload protected and self locking. ExMax...-F actuators are equipped with spring return fail safe function. Standard shaft connection is a double squared direct coupling with 12 x 12 mm.

Different accessories are available to adapt aux. switches, terminal boxes or adaptations for ball valves and throttle valves.

- ▶ For all type of gas, mixtures, vapours and dust for use in zone 1, 2, 21 and 22
- ▶ Universal supply unit from 24 to 230 V - AC/DC
- ▶ 5 different motor running times (3-15-30-60-120 sec./90°), adjustable on site
- ▶ 2 different spring return running times (3-10 sec./90°), selectable on site
- ▶ On-off and 3-pos control with or without spring return function
- ▶ 5 - 10 - 15 - 30 Nm actuators in the same size (S)
- ▶ 100 % overload protected
- ▶ Self locking
- ▶ Compact design and small dimension (l x w x h = 210 x 95 x 80 mm)
- ▶ Direct coupling to the damper shaft with double-squared connection 12 x 12 mm
- ▶ 95° Angle of rotation incl. 5° pre-tention
- ▶ Robust aluminium housing (optional stainless steel or amercoat painting)
- ▶ IP 66 protection
- ▶ Simple manual override include + preparation for comfortable manual override
- ▶ Gear made of stainless steel and sinter metal
- ▶ Only 3,5 Kg weight
- ▶ Integral heater for ambient temperatures down to -40°C
- ▶ Integral safety temperature sensor
- ▶ Integral equipment for manual adjustment (push button, lamp, switch)
- ▶ Preparation for adaptable aux. switches type ExSwitch
- ▶ Range of accessories



ExMax-5.10

ExMax-15.30

ExMax-5.10-F

ExMax-15-F



Special makes

ExMax-..-S/SF

ExMax-..-VA/CT

EXPLOSION PROOF

Technical data	ExMax-5.10	ExMax-15.30	ExMax-5.10-F	ExMax-15-F
Torque motor	5 / 10 Nm selectable on site	15 / 30 Nm selectable on site	5 / 10 Nm selectable on site	15 Nm
Torque spring return (F)	without F	without F	min. 10 Nm	min. 15 Nm
Dimension of external torque	above mentioned torques are min. torques in blocked position, external torque should be max. 80 % of max. actuator torque but min. 3 Nm			
Supply voltage/Frequency	24...230 VAC/DC, + 15 % / - 20% , self adaptable, Frequency 50...60 Hz +/- 20 %			
Dimension	max. starting currents see table (in acc. with voltage, I <sub>start</sub> >> I <sub>rated</sub> ), max. 20 W blocking position, approx. 16 W for heater			
Protection class	class I (grounded)			
Angle of rotation and indication	95°, incl. ~ 5° pre-tention, mechanical value indication			
Working direction	selectable by left/right mounting to the damper/valve shaft			
Motor running time	3 / 15 / 30 / 60 / 120 sec. at 90° selectable on site			
3 sec. mode - motor	In acc. with the supply voltage and external torque 3 to 4 sec at 90° Angle of rotation			
Motor	brushless DC Motor			
Spring return (F)	without F	without F	spring return in the event of loss of power	
Spring return running time (F)	without F	without F	spring return in 3 sec., or 10 sec. at 90°, selectable on site	
3 sec. mode - spring return	without F	without F	in acc. with external torque 3 to 4 sec. at 90° Angle of rotation	
Safety operations at 10 sec (F)	without F	without F	min. 10.000 in acc. with construction of damper and ambient	
Safety operations at 3 sec (F)	without F	without F	min. 1.000 in acc. with construction of damper and ambient	
Response time spring return	up to 1 sec. after power failure			
Control mode	On-off and 3-pos in acc. with wiring, selectable on site			
Axle of the actuator	double squared 12 x 12 mm, direct coupling, 100 % overload protected and self locking up to 15 Nm			
Electrical connection	cable, ~1 m, diameter of wires 0,5 mm <sup>2</sup> , for connection inside hazardous areas an EEx-e terminal box is required!			
Diameter of cable	~ Ø 7,1 mm	~ Ø 7,1 mm	~ Ø 7,4 mm	~ Ø 7,4 mm
Cable gland	M16 x 1,5 standard - cable - and wire entries are integral part of explosions proof encapsulation; tested acc. to EN 50018			
Manual override	Manual override only if supply voltage is cut, use delivered socket wrench, slow motion, enough torque/force is required <b>Attention:</b> with manual operation of actuators with spring return danger of injury exists, with release/let go the hexagonal spanner.			
Integral heater	integral heater, controlled, for ambient temperature down to - 40°C			
Housing material	Aluminium die cast housing, painted (optional in stainless steel version AISI 316 - type ExMax-...-VA, amercoat painting type ExMax ...-CT)			
Dimensions	l x w x h 210 x 95 x 80 mm, for diagramm see extra information "ME"			
Weight	~ 3,5 Kg Aluminium housing (stainless steel ~ 7 Kg)			
Ambients	storage temp. - 40..+ 70°C, working temperature - 40..+ 40°C at T6 and - 40...+ 50°C at T5, humidity in acc. with EN 60335-1			
Operation mode at				
runningtime motor 3 sec	The motor will work in 3 seconds only after 1 minute voltage supply. While open/close-operation (open voltage supply and shut it down) the motor works only with speed 15 sec./90°			
Operation mode at				
runningtime motor 15 sec	at 15/30/60/120 sec. 100 % ED			
Self adjustment	if you select 3 sec. and 15 sec. mode for motor you need to start the self adjustment mode			
Maintenance	maintenance free, maintenance must be complied with regional standards, rules and regulations			
Wiring diagrams (SB)	SB 1.0	SB 1.0	SB 2.0	SB 2.0
Delivery	1 actuator, 1 m cable, double squared shaft connection 12x12 mm, 4 screws M 4 x 100, 4 nuts M 4 socket wrench for simple manual override			
Parameter at delivery	5 Nm, 30 sec./90°	15 Nm, 30 sec./90°	5 Nm, 30 sec./90°	15 Nm, 30 sec./90°

Explosion proof	ExMax actuators - size S
PTB-tested	PTB 04 ATEX 1028 X
In acc. with ATEX	RL 94/9/EG (ATEX)
Approval for gas	II2G EEx d[ia] IIC T6/T5 gas, mist, vapour, zone 1 and 2
Approval for dust	II2D IP66 T80°C dust, zone 21 and 22
Identification	CE No. 0158
EMV	EMV-RL 89/336/EG
Low voltage	Low-voltage RL 73/23/EG
IP-Protection	IP 66, in acc. with EN 60529
Potential compensation	external PA-terminal, 4 mm <sup>2</sup>

Accessories or special solutions - size S	
ExMax-...-S	2 internal, potential free aux. switches at 5°/85°, 24V/3A, 230V/0,25A, SB 3.5
ExMax-...-VA	above listed types in stainless steel V4A / AISI 316 Cd / DIN EN 1.4581 / X5CrNiMoNb 1810
ExMax-...-CT	above listed types in Al-housing with amercoat painting, parts nickel-plated
ExBox-...	EEx-e terminal boxes for zone 1, 2, 21, 22.
MKK-S	mounting bracket for EEx-e terminal boxes type ExBox-... direct on actuator
ExSwitch	2 external aux. switches, adjustable, for zone 1, 2, 21, 22
KB-S	clutch for damper shafts Ø 10...20 mm and Ø 10...16 mm.
HV-S	comfortable manual override for ExMax actuators size S
Adaptations	various adaptations for dampers/valves on request
AR-12-xx	Reduction of square damper connection from 12 mm to 11, 10, 9, 8



Electrical connection

ExMax actuators are equipped with a universal supply unit working at a voltage range from 24 to 230 VAC/DC. The supply unit is self adjustable to the connected voltage! The safety operation of the spring return function works if the supply voltage is cut. For electrical connection inside hazardous areas an EEx-e terminal box, certificated in acc. with ATEX is required (e.g. ExBox).

Wiring diagram ExMax-5.10 and ExMax-15.30

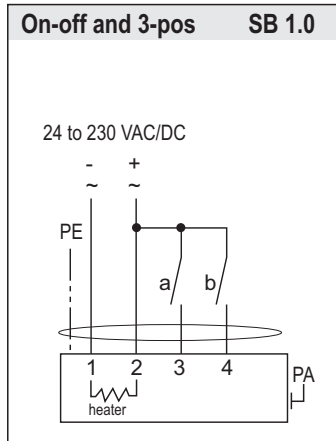

If 3 sec. mode is selected, the self adjustment of Angle of rotation must be started and operation mode of max. 10% ED must be guaranteed. Never use actuators in this mode without external torque/force.

Parameter, Adjustment - Failure indication

Switch - Push button - Lamp for adjustment, behind the blanking plug

- 10-position switch (S)
Push button(T)
3-colour LED

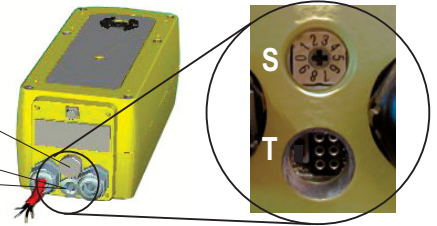

Wiring diagram ExMax-5.10-F and ExMax-15-F (with spring return)

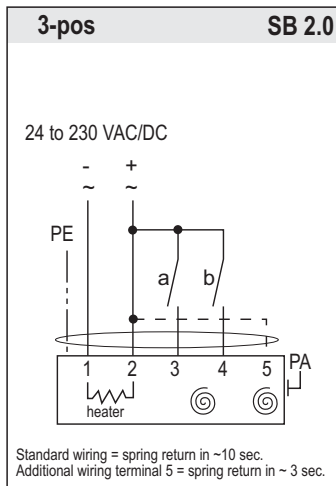

If 3 sec. mode is selected for motor and/or spring return, the self adjustment of Angle of rotation must be started and operation mode of max. 10% ED must be guaranteed. Never use actuators in this mode without external torque/force.

Parameter selection

Example: ExMax-15.30

Requested parameter: Torque 30 Nm, Running time motor 30 sec/90°

Result: switch position (S) 07

Table with columns: Type, Torques, Running times, Position of switch S. Includes rows for ExMax-5.10, ExMax-15.30, ExMax-5.10-F, ExMax-15-F and a grid for running times and switch positions.

Function, adjustment and parameter

A) Self adjustment of Angle of rotation:

Switch (S) into position 02 (low torque) or 07 (high torque), then push button (T) for minimum 3 seconds. The actuator will drive into both end positions to be adjusted. LED indicates green.

Adjustment time needs approx. 60 sec. (30 sec. On, 30 sec. Off). After that, switch S into position 00-09 in acc. with your required torque and running time.

B) Selection of running time and torque:

Put switch (S) into the correct/selected position in acc. to above table.

The selected parameter will work at next operation of the actuator.

Adjustment can be done even without supply voltage. If supply voltage is available turn switch only if actuator is not running.

C) Running time spring return:

The running time of 3 or 10 sec. spring return is selected by wiring (see wiring diagrams SB2.0).

D) Additional information for 3-pos operation:

a closed, b open = direction I

b closed, a open = direction II

a and b closed = Motor doesn't work

a and b opened = Motor doesn't work

Direction (I and II) depends on left/right mounting of the actuator to the damper/valve.

You can change direction of the motor by changing electrical wiring terminal 3 and 4.

Wiring diagram type ExMax...-S with integral aux. switches

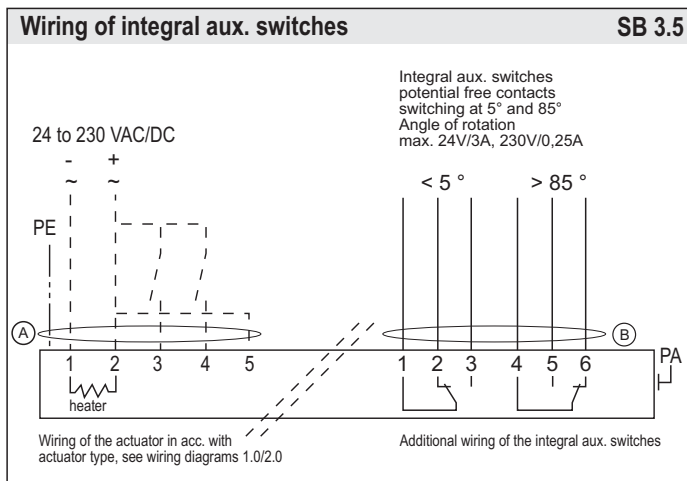

Error indication

See extra information "EL"



ExMax-5.10

ExMax-15.30

ExMax-5.10-F

ExMax-15-F

**SCHISCHEK**  
EXPLOSIONPROOF

Special makes

ExMax-..-S/SF

ExMax-..-VA/CT

**Mounting instructions and important information for operation and installation****Important information for installation and operation****A. Installation, commissioning, maintenance**

The cable of the actuator must be installed in a fixed position and protected against mechanical and thermal damage. In acc. with operation ExMax actuators are maintenance free. Nevertheless maintenance must comply with regional standards, rules and regulations. The flameproof enclosure is protected against mechanical shock in acc. with EN 50014, Abs. 23.4.3.1 by the housing of the actuator. The actuators must not be opened by the customer. For outdoor installation a protective housing against rain, snow and sun should be applied to the actuator, as well as a constant supply at terminal 1 and 2 for the integral heater. For electrical connection inside hazardous areas an EEx-e terminal box is requested (e.g. type ExBox).

**Attention:** If the actuator is put out of operation all EEx-rules and regulation must be applied.

**Example:** you have to cut the supply voltage before opening an EEx-e terminal box

**B. Shaft connection, selection of running time, heater**

ExMax actuators are equipped with a direct coupling double squared shaft connection of 12 x 12 mm. For round shafts an adaptor is available (Accessory type KB-S). The housing of the actuator is axially symmetrically built to select open/close direction of the spring return function by left/right mounting.

In acc. to the actuator type 5 different motor running times and 2 different spring return running times can be selected on site. The integral heater is for ambient temperatures down to -40°C.

**C. Working with 3 sec. motor running time**

See extra information "EL".

**D. 3-pos control mode**

See extra information "EL".

**E. Spring return**

Spring return function works if the supply voltage (terminal 1 or 2) is cut. In the event of an electrical interruption, the spring returns to its end position.

**F. Operation at an ambient temperature below - 20°C**

See extra information "EL".

**G. Excess temperature**

In acc. to the ATEX rules and regulations EEx actuators must be protected against excess temperature. An internal thermostat guarantees the temperature class in the event of failure. If this thermostat is working the actuator must be sent to the factory. ExMax actuators are equipped with an additional temperature sensor to stop the actuator before reaching this max. temperature. In this case the failure must be eliminated immediately on site.

**H. Loss of voltage**

In switch position 0, 1 and 5, 6 (motor running time 3, 15 sec.) and after voltage interrupts moves the actuator (type 5.10 and 15.30 /-S) in OFF position then the actuators works regarding control signal.

**Extra information "EL" (see additional data sheet)**

extra technical information, versions of circuit diagrams and failure indication

**Extra information "ME" (see additional data sheet)**

extra technical information, dimensions, installation instruction and illustration

**Mounting on air dampers with double squared shaft connection**

Details see extra information "ME".

**Mounting on air dampers with clutch**

Details see extra information "ME".

**Mounting of quarter turn valves**

Details see extra information "ME".

**ExSwitch - adaptable external EEx-d aux. switches**

ExSwitch is an accessory to ExMax actuators size S, fixing directly onto the actuator. ExSwitch are aux. switches with 2 potential free contacts, adjustable on site. The electrical wiring needs an EEx-e terminal box.

**ExBox - adaptable EEx-e terminal box**

For electrical connection of an ExMax inside the hazardous area an EEx-e terminal box is required. **ExBox-3P** for ExMax-5.10, ...-15.30, ...-5.10-F, ...-15-F **ExBox-Y/S** for ExMax-...-S integral aux. switches To adapt the ExBox direct to the actuator housing an additional accessory **type MKK-S** is required.

D.EM-01.09-S-en-3P  
2007-10-11



# ExMax/RedMax - extra information EL



The "EL"-data sheet contains additional information for ExMax and RedMax actuators of the size "S", for the optimization and simplification in regard to planning, installation and initial startup. It provides influences of external factors in reference to the safe initiation of the actuators, as well as technical references and problem solutions (error indication). With the error indication, functions can be examined and different error/problems can be adjusted locally.

- ▶ Power supply design
- ▶ Design of line cross section 24...48 VAC/DC
- ▶ Wiring alternatives for on-off, 3-pos, BF actuators
- ▶ Wiring alternatives for modulating actuators
- ▶ Use at ambient temperatures down to -20°C / - 40°C ( )
- ▶ Error indication - problem treatment/solution

For additional mechanical data have a look at "extra information ME"

## Power input depending of supply voltage

### Power supply design

The design of the on-site supply, depends on the selected motor running time and selected supply voltage. Accompanying values are "about values", since there can be construction unit dispersions within electronics. The power consumption in the blocking position is run time independently with max. 20 W. The power consumption for the heater is approx. 16W. The heading is running only if the motor is in idle position! The initial starting supply voltage required by the actuators power supply unit is around 2,0 A for about 1 Sec. (Please consider this while conceiving the cross section of the supply line)

Voltage	Current	Rated current in acc. with motor running time				
		3/7,5s	15s	30s	60s	120s
230 V	I <sub>rated</sub>	0,5 A	0,3 A	0,15 A	0,10 A	0,10 A
120 V	I <sub>rated</sub>	0,75 A	0,4 A	0,3 A	0,25 A	0,25 A
48 V	I <sub>rated</sub>	2,0 A	0,5 A	0,3 A	0,2 A	0,2 A
24 V	I <sub>rated</sub>	4,7 A	1,45 A	0,52 A	0,4 A	0,4 A

## Dimensioning of the line cross section with 24 ...48 VAC/DC supply voltages

### Dimensioning/Design of the supply line

On long distances between voltage supply and drive, voltage drops occur due to line resistances. As a consequence with 24 VAC/DC the actuator receives a too low tension and does not start. In order to prevent this, the cross section of the inlet line is to be designed/dimensioned accordingly. The accompanying formula allows the calculation of the necessary line cross section, perhaps provides the maximally permitted conduit length utilizing the existing line cross section. Alternatively the secondary voltage can be increased by selecting a transformer. For calculation purposes, following characteristics are essential:  
 U<sub>v</sub> = supply voltage in [V]  
 A = line cross section in [mm<sup>2</sup>]  
 L = conduit length in [m]  
 Factor 0.0714 = drive-specific factor  
 [Vmm<sup>2</sup>/m] ( based on the electrical conductivity of electrolytic copper with a coefficient of 56m/Wmm<sup>2</sup>)

Formula for max. cable length "L" at cable cross section "A"

$$L = A \cdot (U_v - 18V) : 0,0714$$

Example: A = 1,5 mm<sup>2</sup>, U<sub>v</sub> = 24 V  
Length of cable L = 126 m

Formula of needed cable cross section "A" at a cable length of "L"

$$A = 0,0714 \cdot L : (U_v - 18V)$$

Example: L = 250 m, U<sub>v</sub> = 30 V  
Cross section of A = 1,5 mm<sup>2</sup>

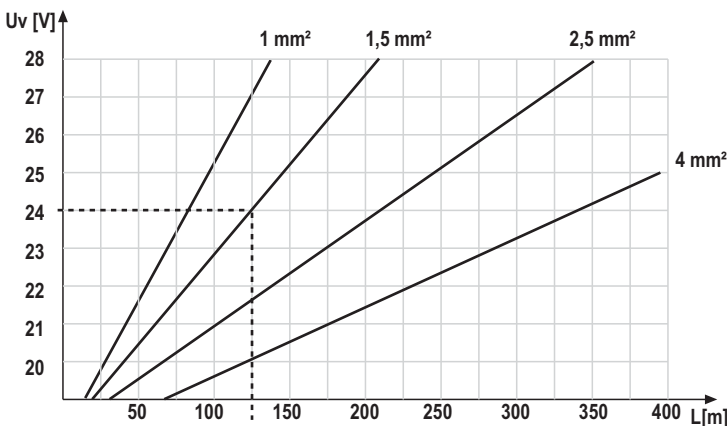

Example:  
24 V power supply with wire diameter 1,5 mm<sup>2</sup> = 126 m



## Wiring alternatives for on-off and 3-pos actuators with spring return

ExMax...-F, ExMax...-SF, RedMax...-F, RedMax...-SF

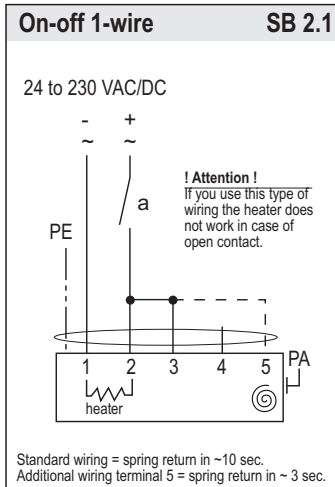
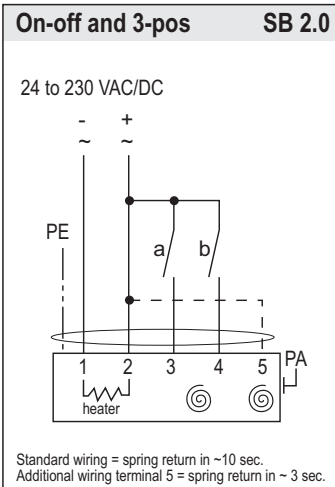

**! Attention! !**

If 3 sec. mode is selected, the self adjustment of angel of rotation must be started and operation mode of max. 10% ED must be guaranteed.  
Never operate actuator in the 3 sec mode without an outside load of min. 3 Nm.

Engaging 1 wire On/Off controls in the 3 sec. modus with spring return is not possible. The actuator can only be operated with 1 On/Off function per minute otherwise electronics will be liable to overheating.

See additional note 3 sec. motor running time

## Wiring alternatives for BF actuators

ExMax...-BF, RedMax...-BF

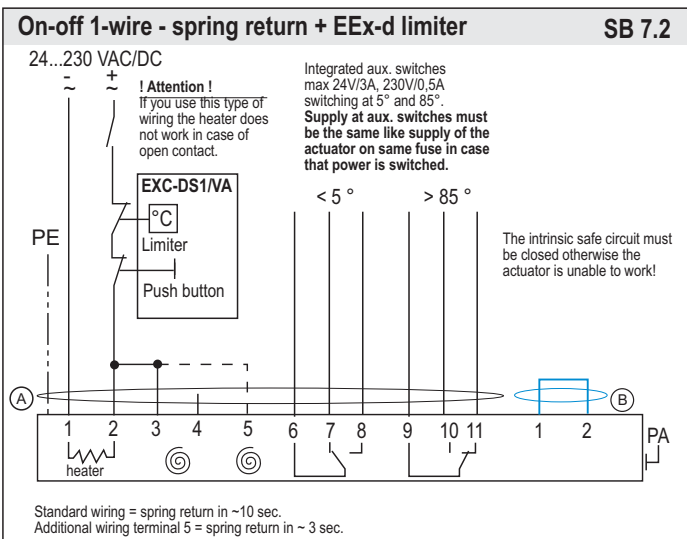
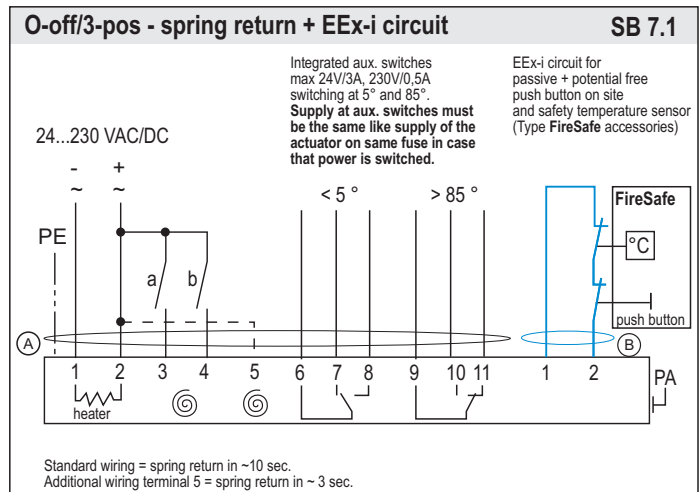
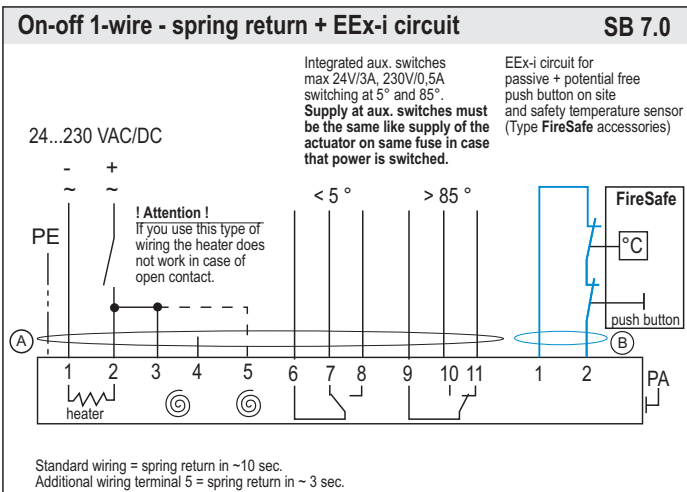

**Values of the EEx-i circuit**

U<sub>0</sub> = 10,6 V  
I<sub>0</sub> = 11 mA  
P<sub>0</sub> = 30 mW  
C<sub>i</sub> = 0  
L<sub>i</sub> = 0

	IIC	IIB	IIA
C <sub>0</sub>	830 nF	3,7 μF	4,5 μF
L <sub>0</sub>	2 mH	5 mH	10 mH

**! Attention! !**

If 3 sec. mode is selected, the self adjustment of angel of rotation must be started and operation mode of max. 10% ED must be guaranteed.  
Never operate actuator in the 3 sec mode without an outside load of min. 3 Nm.

Engaging 1 wire On/Off controls in the 3 sec. modus with spring return is not possible. The actuator can only be operated with 1 On/Off function per minute otherwise electronics will be liable to overheating.

See additional note 3 sec. motor running time



## Wiring alternatives for modulating actuators with or without spring return

ExMax-...-Y..., RedMax-...-Y..

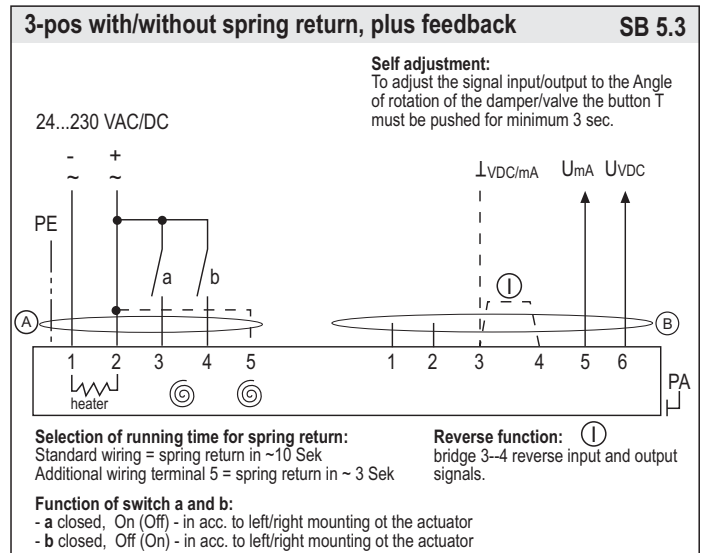
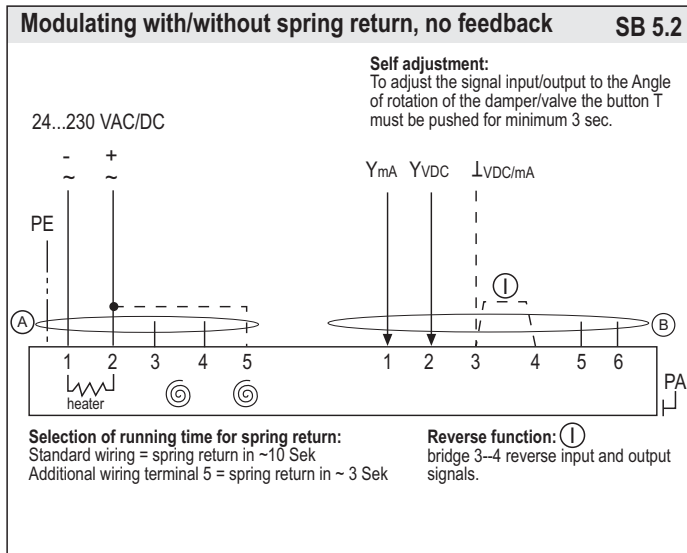
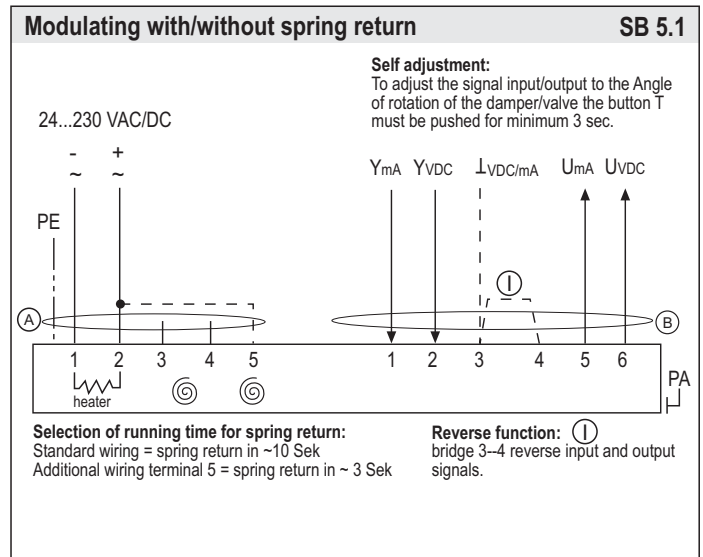
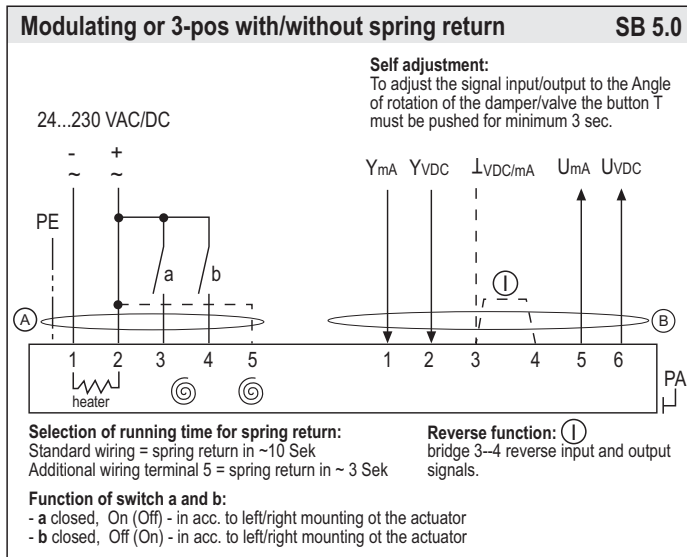

### 3-sec. mode, 3-pos-operation, heating by low ambient temperatures

#### I. Operation with 3 sec. motor running time mode

Note following at 3 sec. motor running time:

- The 3 sec. motor running time mode is only in switch position 0 and 5 and at a constant supply voltage on terminals 1 and 2 which must be in minimum for 1 minute applied available.
- The actuator opens at voltage on terminal 3 (resp. closes), and closes at voltage on terminal 4 (resp. opens) depending on mounting position of the actuator.
- The max. duty ratio is 10 % resp. 1 cycle / minute. Between two fully cycles to the same direction there must be a minimum intermission of 1 minute. The actuator is blocked if the break time is less than 1 minute. The release for the next cycle is made automatically by an internal timing relay.
- Same function is applied on spring return actuators. Fail safe operation is regarded same as a motor running cycle.
- If its tried to use the 1 wire On/Off methode in switch position 0 and 5, software changes the running time temporarily and automatically to 15 sec. motor running time to protect the actuator for overheating due to uncontrolled duty ratio.
- The actuator must be operated with an outside load of at least 3 Nm.
- After installing the actuator to the damper/armature an automatic alignment has to be accomplished, in order to obtain a „gentle blockade/stop“. This function protects the damper/armature by reducing the end positions/blockade speed in order to avoid mechanical overload. The actuator alignes specifically once with 30 Sec/90° onto each position, recognizes the blockade position in order to reduce the motor performance

during operation briefly before reaching the end /blockade position.

#### II. 3-pos operation

ExMax (RedMax) actuators are in the best way suitable for the 3-pos operation. To protect such elements as gears and mounting elements against harmful influences like minimum pulse time, ExMax (RedMax) actuators are protectet via internal electronics. The internal electronic permits 20 impulses with < 0.5 > sec. cyclic duration, afterwards at least 1 impulse > 1 sec. must follow. If clocked with more than 20 impulses each < 1 sec. the actuator will adjust into a suspend mode. There after a reset is mandatory and will be achieved by briefly switching of the supply voltage for about 2 sec.. The controll unit has to be parameterized in order to be set within the above mentioned duration limits.

#### III. Use at low ambient temperature below -20°C

All ExMax (Redmax) actuators are equipped with a regulated integrated heating device designed for employments down to -40°C ambient temperature.

The heater will be supplied automatically by connecting the constant voltage supply on the clamps 1 and 2.

Following parameters are to be considered by ambient tempaure < 10°C:

- After mounting the actuator must bei immediately electrically connected.
- The actuator will only be activated after the operating temperature has reached at least -20°C .
- The adjustment options are only ensured after this heating up period.



## Error indication

Error/Symptom	Reason	Solution
01 Actuator does not work LED does not lights	<ul style="list-style-type: none"> <li>No power supply attached</li> <li>The actuator is operated beyond ex-prevention ambient temperature specifications and the internal temperature sensor did irreversibly shut down operations</li> </ul>	<ul style="list-style-type: none"> <li>Attache power supply and turn on</li> <li>Because of inadmissible operation the actuator drove out of safety relevant reasons into an irreversible condition and must be exchanged. Accompanying new installation the ambient temperature has to be reduced accordingly</li> </ul>
02 Actuator does not work LED lights red	<ul style="list-style-type: none"> <li>The actuator is operated by a too high ambient temperature and the internal temperature sensor responded</li> </ul>	<ul style="list-style-type: none"> <li>Shut off actuator and let temperature decrease, reduce ambient temperature by suitable measures e.g. ventilation or other mounting position of the actuator</li> </ul>
03 Actuator does not work LED lights green	<ul style="list-style-type: none"> <li>3-Pos control signal is wired on both entrances</li> <li>Required torque is greater than actuators torque</li> <li>Control signals are not attached or attached on a wrong conductor</li> <li>Actuator is incorrect mounted and is blocked by an external stop unit</li> <li>Actuator is clocked with more than 20 impulses &lt;0,5 per sec. and therefore adjusted into suspend mode</li> <li>Interchanged supply lines</li> </ul>	<ul style="list-style-type: none"> <li>Readjust/correct circuit</li> <li>Adjust a higher torque at the actuator if possible otherwise exchange for a type with higher torque.</li> <li>Examine rule and adjusting signal in accordance with attached diagram</li> <li>Dismount actuator and testdrive without load for operability. Install actuator accordingly that the power transmissions runs without external blockade or torsion</li> <li>Switch off supply voltage for at least 2 sec. thereby a reset is conducted Readjust controller in order to extend control pulses</li> <li>Wire 1 must be (-, N) and wire 2 (+, L)</li> </ul>
04 Actuator does not work LED is red blinking	<ul style="list-style-type: none"> <li>The actuator has been mounted by temperatures of less than -20°C and did not reach its operating temperature of at least -20°C.</li> </ul>	<ul style="list-style-type: none"> <li>Ensure that a constant voltage supply on conductor 1--2 is existing.</li> <li>Wait until the required operating temperature is achieved by the actuators internal heating system. The actuator will start operating independently</li> </ul>
05 Spring return funktion is 10 sec./90°, should however amount to 3 sec./90°	<ul style="list-style-type: none"> <li>Bridge 2 --5 is not established</li> </ul>	<ul style="list-style-type: none"> <li>Bridge conductor 2 of the constant voltage supply with conductor 5</li> </ul>
06 Spring return funktion is 3 sec./90°, should however amount to 10 sec./90°	<ul style="list-style-type: none"> <li>Bridge 2 --5 is established</li> </ul>	<ul style="list-style-type: none"> <li>Disconnect bridge</li> </ul>
07 Actuator does not start after more than 2 briefly following adjusting functions in the 3 sec. mode where set	<ul style="list-style-type: none"> <li>The maximal permissible cyclic duration of 10% ED was not complied to, the actuator is in a safety disconnection mode</li> </ul>	<ul style="list-style-type: none"> <li>Wait approx. 1 minute until internal electronics cool down to operating temperature.</li> </ul>
08 Y-drive in the 3-pos mode can not gear into intermediate positions	<ul style="list-style-type: none"> <li>The conversion of constant mode on 3-pos-modus was not set</li> </ul>	<ul style="list-style-type: none"> <li>Recalibrate the actuator in accordance with assembly instructions</li> </ul>
09 Actuator sits diagonally on the squared damper shaft	<ul style="list-style-type: none"> <li>The actuators have an angle of rotation of 95° inclusive 5° pre-tention. While assembling the pre-loading was not considered</li> </ul>	<ul style="list-style-type: none"> <li>Dismount actuator of the damper, use the enclosed socket wrench to draw up approx. 5° over the hand operated control device before remounting on the damper shaft. Consider additional information ME of the assembly instructions</li> </ul>
10 Actuator is with clamp stand KBS actuated installed onto damper shaft and does only partly or not at all drive	<ul style="list-style-type: none"> <li>Provided that the electrical basic conditions specified above are fulfilled, the anti-twist plate could be so installed that the actuator blocks itself due to the twisted and not centric shaft connection and therefore interlocks</li> </ul>	<ul style="list-style-type: none"> <li>Loosen the anti-twist plate and remount that the actuator can implement an easy oscillation motion over its angle of rotation</li> </ul>
11 A modulating actuator (Y) works with reduced angle of rotation and already reaches its end positions before 0 V/4 mA, respectively before 10V/20mA.	<ul style="list-style-type: none"> <li>At start up no self adjustment of angle of rotation was accomplished</li> </ul>	<ul style="list-style-type: none"> <li>Accomplish self adjustment of angle of rotation in accordance with assembly instruction</li> </ul>
12 LED flashes irregularly and actuator does not work	<ul style="list-style-type: none"> <li>Actuator does not receive sufficient supply voltage</li> <li>Cable too long, voltage drop in the supply line to large</li> </ul>	<ul style="list-style-type: none"> <li>Increase line cross section or increase tension at the transformer/power supply unit</li> <li>Increase line cross section or increase tension</li> </ul>





# ExMax/RedMax - extra information ME



The "ME"-data sheet contains additional information for ExMax and RedMax actuators of the size "S", for the optimization and simplification in regard to planning, installation and initial start up. It provides influences of external factors in reference to the safe initiation of the actuators. In particular it represents the installation, as well as different dampers, fire protection dampers and armatures. Additionally describing different accessory elements and their mounting to the actuator.

- ▶ Dimension, drill template
- ▶ Control elements: switch - push button - LED
- ▶ Outdoor installation
- ▶ Mounting using form-fitting shaft connection (square shaft)
- ▶ Mounting using clamp mounting (round shaft)
- ▶ Mounting on butterfly valves and ball valves
- ▶ Mounting on fire dampers
- ▶ Mounting ExBox (RedBox), ExSwitch (RedSwitch)

For additional electrical data have a look at "extra information EL"

## Dimensions - drill template

### Dimension size S

Dimension in mm

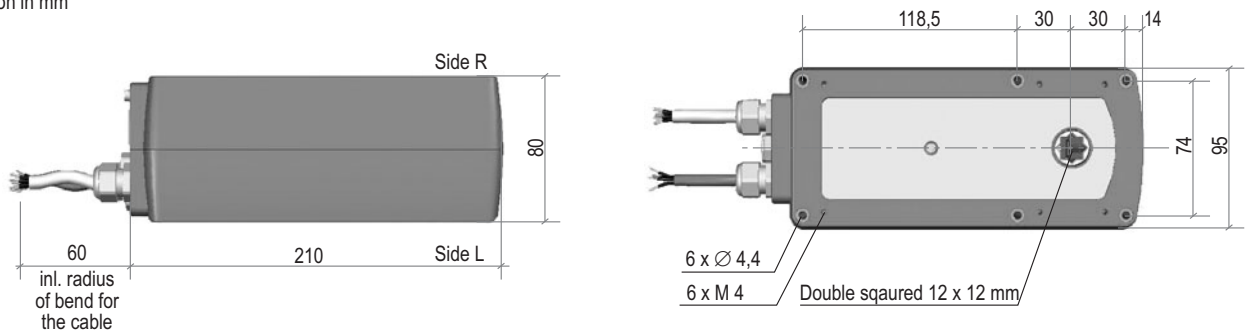

## Control elements: switch - push button - LED

### Specification

All ExMax and RedMax actuators are equipped with a 10 position switch a push button and a multicolor LED for calibration. These control elements are to be found cable-laterally behind the two middle sectioned dummy plugs. For operation these must be removed. The calibration can be achieved despite lining up tension at the actuator. The explosion prevention is not impaired thereby. However it has to be of great concern that the dummy plugs must be rescrewed in order to comply with the IP-protection class. The operation of the switch and button has to be done by means of a small screwdriver. Force with strong pressure and /or rotation is to be avoided in any case, since otherwise control electronics can be damaged irreparably. By bad visibilities a flashlight (certified within the EX-range) should be used. Attitudes of torque and running time can be achieved also before mounting. The adjustment of angle of rotation can be started only with an outside load and accurate mounting.

### Switch - push button - LED for programming, behind dummy plug

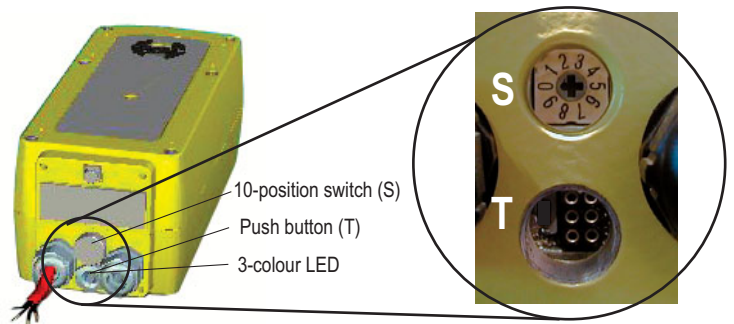

## Outdoor installation

### Specification

When mounting actuator outdoors it has to be certain that the actuator is protected against direct sun exposure (heat and UV), rain and snow by employing an enclosure roof. Supply voltage is to be applied immediately after mounting in order to assure integrated heating at start. Since explosion proof actuators must have internal safety temperature limiters, these may not be exposed neither at storage nor during operation to a too high temperature. Otherwise the limiters could respond and switch of the actuator irreversibly.

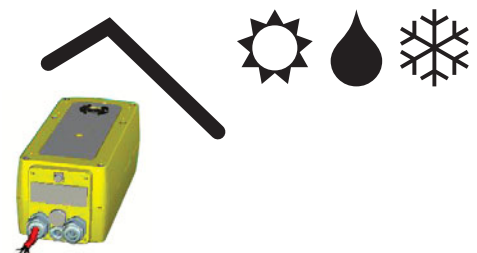



## Mounting instruction for ExMax and RedMax actuators size S on air dampers

### Specification

ExMax and RedMax actuators size S are equipped with a 12 x 12 mm (double square) shaft connection. The form-fitting shaft connection is the securest connection between damper shaft and actuator because slipping or slipping through is avoided compared to the force-fit clamp-connection. The actuator will be connected firmly by means of four screws M 4 x 100 (scope of supply) to the damper. For the connection to round damper shaft or square damper shaft with smaller or larger 12x12 mm an optional mounting clamp (type KB-S) for tensionally locked connections is available.

### Form fitting mounting on square damper shaft

**Dimension damper shaft**

**Length A**  
Dimension A in acc. with indicator  
1. Actuator without indicator      A = no limit  
2. Actuator with indicator, no accessories      A < 65 mm

12 x 12 mm

M4 x 100

4 screws M4 x 100, as well as a socket wrench, are part of delivery for ExMax/RedMax actuators size "S".  
For damper shafts 9 x 9, 10 x 10 or 11 x 11 mm reducing bush are optional available.

### Mounting clamp type KB-S

Dimension squared damper shaft	Dimension round damper shaft
<p>Length A &lt; 25 mm</p>	<p>Length A &lt; 25 mm</p>
<p>1. Pre-assembly clamp</p>	<p>2. Fixing the clamp</p>
<p>3. Pre-assembling mounting bracket</p>	<p>4. Mounting to the damper</p>

### Mounting instructions form-fitting shaft connection

It is to be considered that the actuators have a total angle movement of approx. 95° in order to realize a pre-tension on the damper. Therefore the actuator sits tilted on the damper shaft. In order to prevent this and to assure pre-tension to the damper the driving shaft has to be adjusted mechanically before connecting to the damper shaft. The provided socket wrench serves for the mechanical adjustment over the hand-operated control socket HV. The actuators are axially symmetrically developed. In case of spring return function the safety position must be selected by turning the actuator 180°.

#### Mounting:

1. Affix tap hole M4 (in accordance with drill template) on the damper or to a mounting bracket.
2. Adjust drive shaft of the actuator with the socket wrench that the drive stands perpendicular to the damper before plugging actuator on to the damper shaft.
3. Plug actuator onto damper shaft and fix diagonally with 2 screws.
4. Remove the socket wrench.
5. Pivot and tighten the remaining screws.

**Note:** the drive shaft is selflockingly produced and may only be mechanically adjusted either with the provided socket wrench or the optional accessory "HV-S" manual override. External applied force to the shaft can lead to mechanical damage of the actuator.

### Mounting instructions for mounting clamp

The actuators are axially symmetrically developed. In case of a spring return function the safety position must be selected by turning the actuator 180°.

#### Mounting

1. Insert u-bolt connection into drive-shaft and screw the bolt from the opposite side tight with the socket wrench.
2. Screw in two screws functioning as an anti twist locking device.
3. Install mounting bracket at the damper.
4. Plug the actuator to the damper shaft, adjust the actuator in the mounting brackets position and tighten the damper shaft with a wrench socket via the u-bolt connection.

#### Attention!

The actuator must be installed in such a way that it can implement an easy oscillating motion in the mounting bracket for the reconciliation of the not centric connection.

**Note:** the drive shaft is selflockingly produced and may only be mechanically adjusted either with the provided socket wrench or the optional accessory "HV-S" manual override. External applied force to the shaft can lead to mechanical damage of the actuator.



## Mounting instructions for ExMax and RedMax actuators size S on butterfly valve and ball valve

### Specification

ExMax and RedMax actuators of the size S are equipped with a 12x12 mm (double square) form-fitting shaft connection. For mounting to butterfly valves or ball valve a special mounting bracket in acc. with DIN EN ISO 5211 is required. Since this standard provides only certain basic conditions there can be substantial geometrical differences between armatures which require a special adaption.

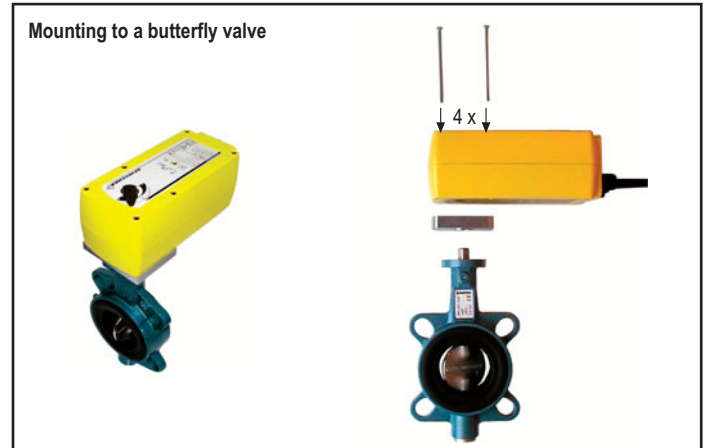
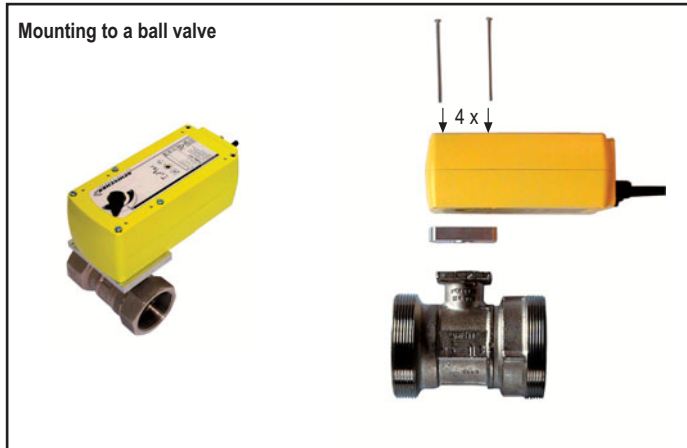

## Mounting instructions for ExMax and RedMax actuators Size S on fire dampers

### Specification

ExMax and RedMax actuators of the size S are equipped with a 12x12 mm (double square) form-fitting shaft connection. The form-fitting shaft connection is the securest connection between damper shaft and actuator. The actuator is fixed with four screws directly to the fire damper and/or fixed to a mounting bracket. ExMax-...-BF and RedMax-...-BF actuators integrate an intrinsically safe circuit in order to connect a FireSafe sensor which works like a temperature limiter.



### Assembly

It is to be considered that the actuators have a total angle of rotation of approx. 95° in order to realize a pre-tension on the damper. Therefore the actuator sits tilted on the damper shaft. In order to prevent this and to assure pre-tension to the damper the driving shaft has to be adjusted mechanically before connecting to the damper shaft. The provided socket wrench serves for the mechanical adjustment over the hand-operated control socket HV. The actuators are axially symmetrically developed. In case of a spring return function the safety position must be selected by turning the actuator 180°.

### Mounting:

1. Affix tap hole M6 (in accordance with drill drill template) on the damper or to a mounting bracket.
2. Adjust drive shaft of the actuator with the socket wrench that the drive stands perpendicular to the damper before plugging actuator on to the damper shaft.
3. Plug actuator onto damper shaft and fix diagonally with 2 screws.
4. Remove the socket wrench.
5. Pivot and tighten the remaining screws.
6. Mount temperatur limiter type Fire Safe
7. Mount terminal box
8. Wire connect actuator and sensor in the terminal box

**Note:** the drive shaft is selflockingly produced and may only be mechanically adjusted either with the provided socket wrench or the optional accessory "HV-S" manual override. External applied force to the shaft can lead to mechanical damage of the actuator.



## Mounting of terminal boxes type ExBox (RedBox) via mounting bracket MKK-S to the actuator (accessory)

### Specification

1. Screw mounting bracket MKK-S to the actuator (A) then terminal box to the mounting bracket (B) schrauben

Mounting bracket MKK-S can be mounted every 90°

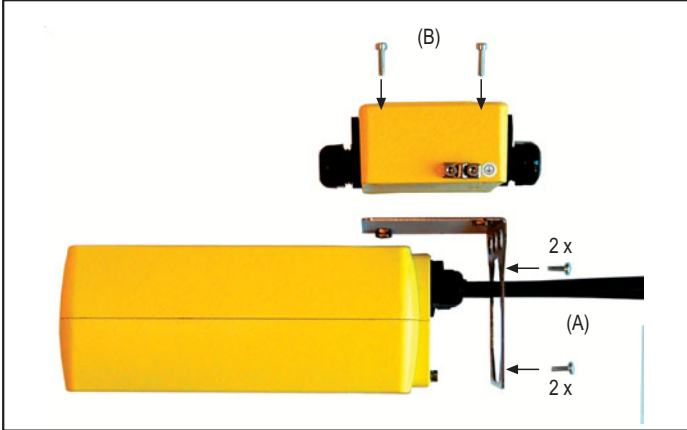

Terminal box mounted above the actuator

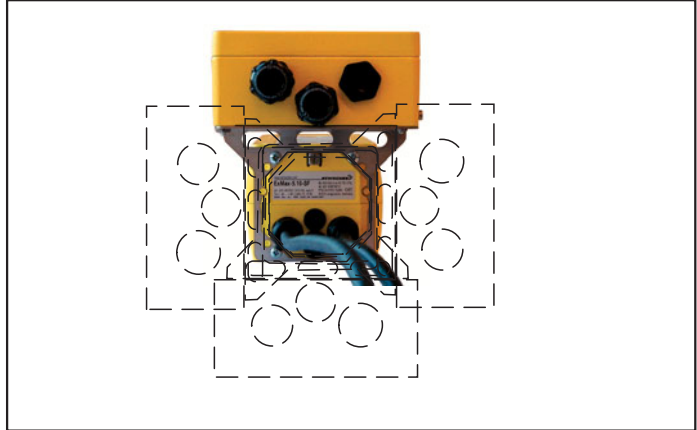

Terminal box mounted beside the actuator

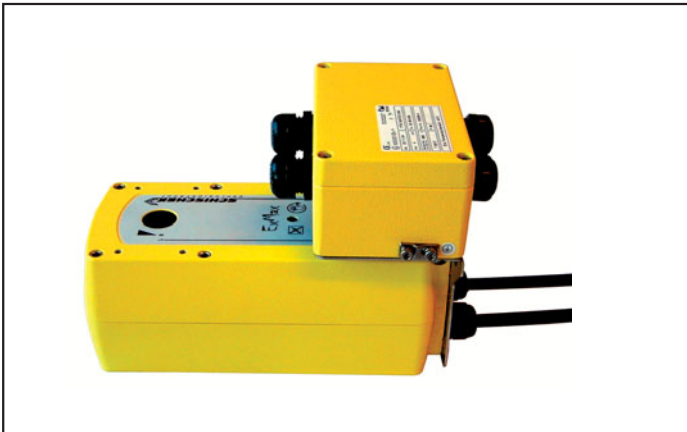

## Mounting of ExSwitch (RedSwitch) accessory to the actuator

### Specification

1. Put the squared connection part to the actuator, then mount ExSwitch (RedSwitch) and fix it with 4 screws

2. ExMax (RedMax) with mounted ExSwitch (RedSwitch)

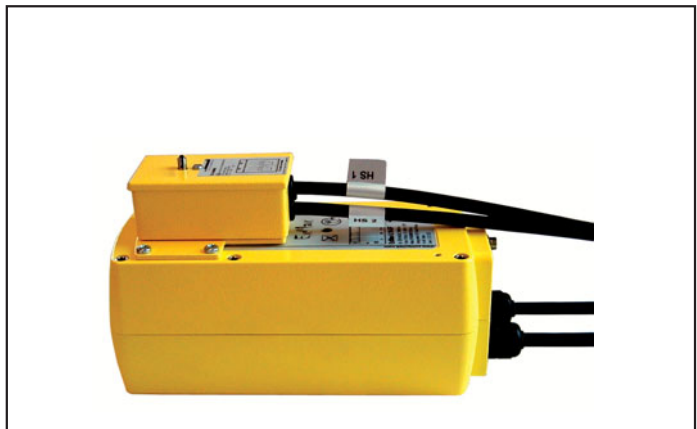
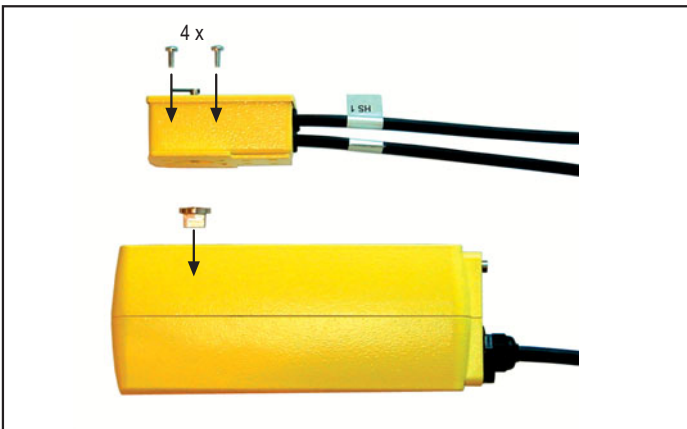

M.MZ-01.01-S-en-Zusatzinfo ME